

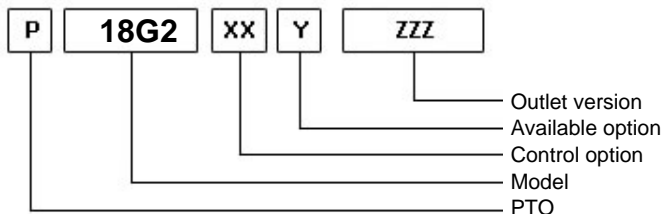

#PTO LAT. L. D. MITSUBISHI MO25S5

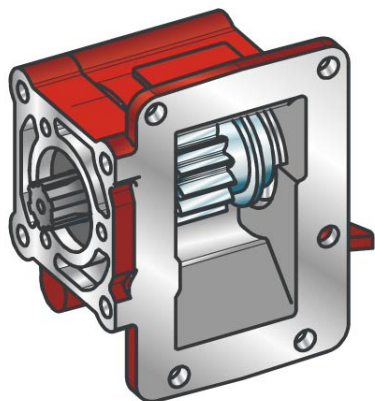

	Output 1		Number of teeth	16
Torque (Nm)	160		Module	2,8
Int. ratio	1		Replace	
Number of axles	1		Replaced by	

22/04/2014

Command type

Electric
 Hydraulic
 Mechanical
 Fixed engagement
 Pneumatic
 Vacuum system

