

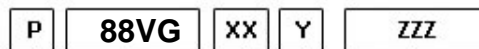

#PTO POS. VOLVO VT CON RETARDER

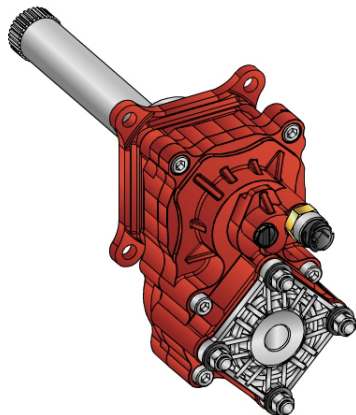

Outlet version
Available option
Control option
Model
PTO

	Output 1	
Torque (Nm)	500	
Int. ratio	1,32	
Number of axles	2	

Number of teeth	12
Module	3,25
Replace	
Replaced by	

27/01/2011

Command type

Electric Hydraulic Mechanical Fixed engagement Pneumatic Vacuum system

