

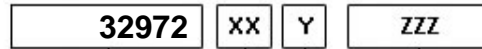

PZB®

D01P-0-03 - Pagina WebPTO PZB - rev. 0

32972

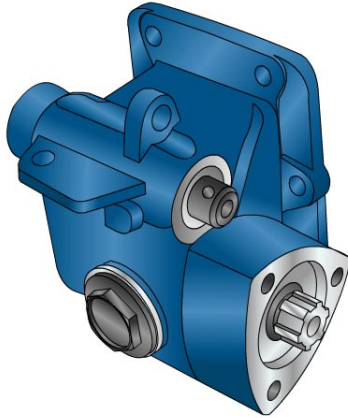

Outlet version
Available option
Control option
Model

	Output 1	
Torque (Nm)	150	
Int. ratio	1	
Number of axles	1	

Number of teeth	16
Module	2,8
Replace	
Replaced by	

09/10/2013

Command type

- [X] Mechanical with lever remote control (TC) [] Hydraulic control [] Pneumatic
- [X] Ready for electric solenoid control [X] Depressure control [] Constantly engaged
- [X] Mechanical with PUSH-PULL remote control [X] Electric control KES 5 [] Ready for detached control

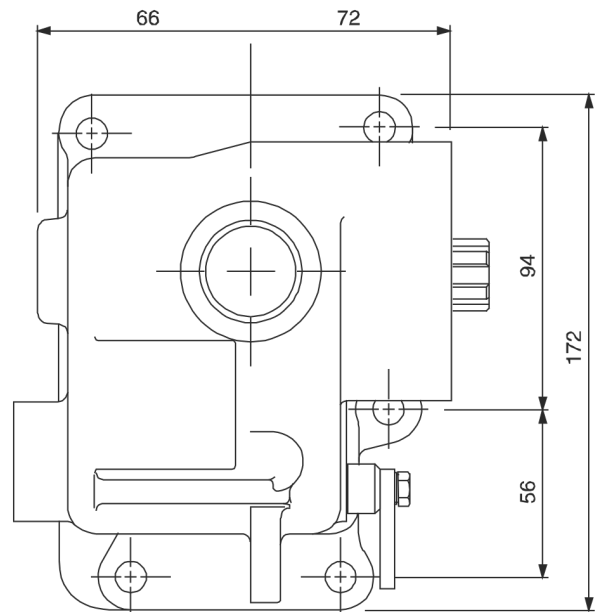
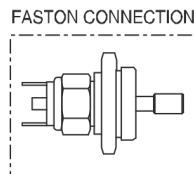
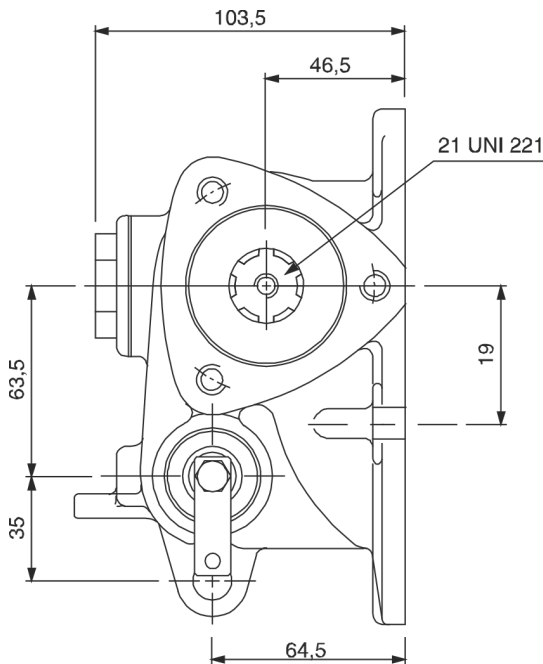

Interpump Hydraulics Spa a socio unico - **Business Unit PZB**

Sede Legale: via A. Mingozzi, 6 • 40012 Calderara di Reno BO - Italy

Sede Operativa: via A. Mingozzi, 6 • 40012 Calderara di Reno BO - Italy • T +39 051 6460511 • F +39 051 6460560 • info@pzbitaly.com • pzbitaly.com

Cap. Soc. Euro 2.631.600,00 i.v. • N. Mecc. BO 056383 • R.E.A. BO 444225 • C.F. 00883010241 • P.Iva IT02128140361

Soggetta ad attività di Direzione e Coordinamento da parte di Interpump Group Spa

